

# **gorenje**



## **BD 2116 AX**

**BUILT-IN MULTI-FUNCTION DOUBLE OVEN**

**INSTALLATION AND OPERATING INSTRUCTIONS**

*As part of our commitment to constantly improving our products, we reserve the right to make changes to them based on advances to their technical, functional and/or aesthetic properties.*

# Introduction

This quality oven has been designed to provide trouble-free service provided it is installed and maintained correctly. This oven is for domestic use only.

Please read these instructions carefully before installing or using your appliance. It is advisable to keep your purchase and installation receipts with these instructions in a safe place for future reference.

Included is some important safety information, guidelines and recommendations to enable you to safely use your oven.

This appliance has been tested and certified to meet all applicable UK electrical and safety standards.

This appliance must only be installed and repaired by qualified electricians or authorised service personnel.

If it is not repaired properly you could be putting yourself and others in danger. It will also invalidate the guarantee.

When contacting the Helpline please have model number to hand. The model number is shown on the data label which is visible by opening the oven door.

# Unpacking

Carefully remove all the packaging and lift out the oven and accessories.

Open the oven and remove any tape or packing material used for transit.

Check the appliance for any damage. If the unit has been damaged **do not use it** and contact the retailer from whom the appliance was bought.

Retain the packaging until the unit has been installed, removing it from the area of installation and keeping it out of the reach of children.

Dispose of all the packaging in accordance with your local authority guidelines as well as any old appliance that is being replaced – see safe oven disposal section.

# Before installation

Before any installation work can be carried out a number of requirements must be met.

Make sure that you or your installer are familiar with all the relevant building and fire regulation requirements before choosing the location of your appliance.

This appliance must be installed in accordance with the instructions to validate the guarantee.

Refer to the “Location” section for minimum clearances and safe placement of your oven.

# Location

Avoid installing the oven too close to a fridge or boiler.

The oven should be installed into an oven housing unit as shown in Figure 1.

Ensure that the surrounding material is heat resistant and non-combustible.

Certain minimum clearances must be allowed for when planning the unit's location.

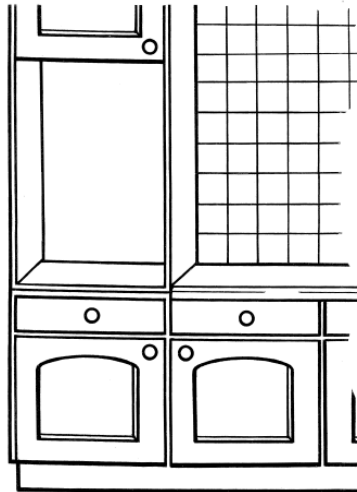

Figure 1 - housing unit

# Housing dimensions

Figure 2 shows the housing dimensions in millimetres.

**It is important to observe the housing dimensions and check your oven housing before attempting to install.**

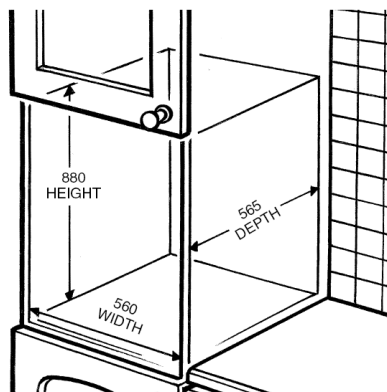

Figure 2 - housing dimensions

# Electricity supply

Once a satisfactory location has been established, the electrical supply to the appliance must be arranged.

The mains voltage must correspond to that which is specified on the data plate.

The supply should be from a 30 amp fused spur, with an isolator switch installed above the work surface and to one side of the unit in case of emergency. The isolator switch must have working contacts separated by 3mm.

This installation must be carried out in accordance with current I.E.E. Wiring Regulations and Building Regulations (Part P).

The mains supply cable from the isolator to the unit must be rated for the maximum power consumed by the unit (also specified on the data plate).

The supply cable must be long enough to allow for servicing the appliance.

The supply cable must be routed away from hot surfaces

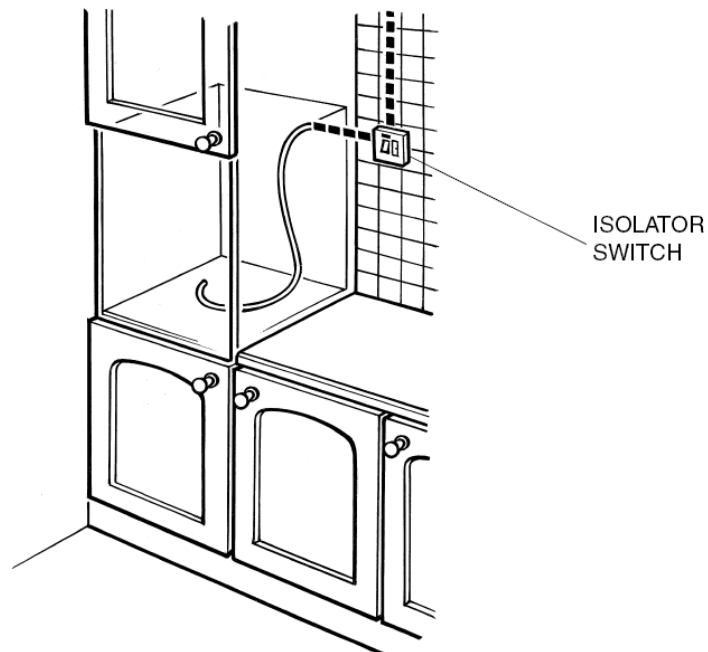

Figure 3 - isolator switch

# Electrical connection

The appliance must be properly connected to the mains supply by a qualified electrician according to current safety regulations.

This appliance must be earthed.

1. Lift up the cover (Figure 4).
2. Loosen the cable clamp (Figure 4).
3. Connect the mains supply cable to the terminal block on the cooker using the following colour code (Figure 4):

- The yellow/green wire should be connected to the earth terminal.
- The blue or black wire should be connected to the neutral terminal.
- The brown or red wire should be connected to the live terminal.

Secure the cable clamp. Check the cable terminals for tightness and ensure that the terminal links are in place, then close the cover over the terminal block.

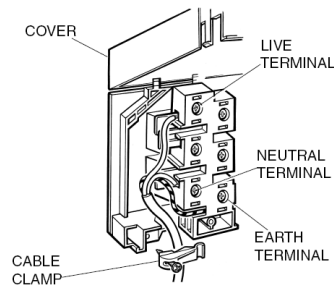
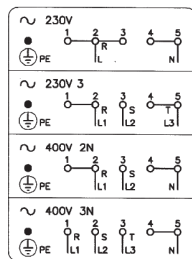

Figure 4 – Electrical connections

## CONNECTION DIAGRAM



## CABLE TYPES AND SECTIONS

H05RR-F	
230V~	3 x 2,5 mm <sup>2</sup>
230V 3	4 x 1,5 mm <sup>2</sup>
400V 2N~	4 x 1,5 mm <sup>2</sup>
400V 3N~	5 x 1,5 mm <sup>2</sup>

# Installing the oven

Place the oven into the housing unit and adjust its position until it is level, making sure it aligns with any adjacent units, drawers, and cupboard doors (Figure 5).

When correctly positioned, drill the unit and secure the appliance in place with four fixing screws (Figure 6).

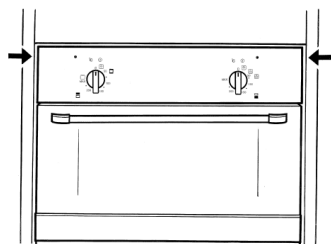

Figure 5 - centralising appliance

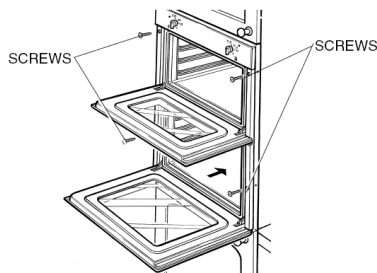

Figure 6 - installing the oven

# Please read these safety notes before using the oven



- Make sure you understand what the oven controls do before using the oven.
- Always turn the oven controls to the OFF position when the oven is not in use.
- Before removing cooked food from the oven open the door carefully to allow any heat to disperse.
- Use dry oven gloves when removing items from the oven.
- Be careful when operating the oven and take care to avoid touching hot elements inside the oven.
- Ensure that the cables of other household appliances used near the working oven are away from its hot elements. Ensure also that the cables are not trapped by the oven door.
- Keep the oven door closed when the oven is not in use.
- Keep the oven clean as a build up of grease or fat from cooking can cause a fire.
- Allow the oven to cool before cleaning.
- Keep any ventilation holes clear of obstructions.



- Never leave children unsupervised where the oven is installed as the appliance will get hot during and after use.
- Never allow anyone to sit or stand on any part of the oven.
- Never heat up unopened food containers as pressure can build up causing them to burst.
- Never store chemicals, food stuffs or pressurised containers in cabinets above or next to the oven.
- Never use the oven as a room heater.
- Never dry clothes or place other items on the oven door.
- Never line any part of the oven cavity with aluminium foil.

# Using the oven

**Please note: When using for the first time the oven may smell for a short time while burning off dust and manufacturing residues from the heating elements. This is normal and does not indicate a fault with the oven.**

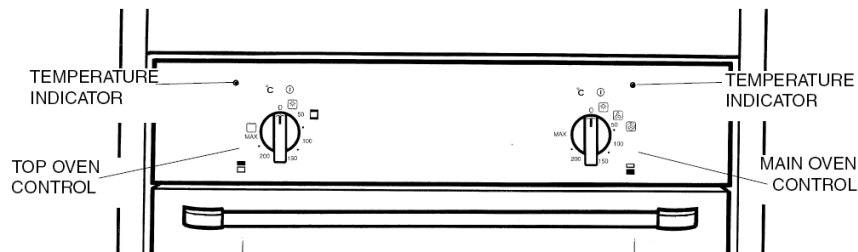

Figure 7 - control panel

The oven is fan assisted and evenly distributes the heat throughout the oven. This may reduce the cooking times compared with a conventional oven so always read the cooking instructions on the packaging when cooking convenience food. It is recommended to preheat the oven for a few minutes or wait until the temperature indicator goes off before placing food in the oven for cooking. Be careful when using aluminium foil. Do not cover the sides of the oven, the shelf or oven interior. If wrapping food in foil the cooking time may increase.

## Main oven controls

The thermostat determines the temperature inside the oven during cooking. Turn the control knob clockwise to align the cooking temperature with the marker on the control panel. The temperature indicator will light up when a temperature is set, and turn off when the temperature has been reached. During cooking the thermostat will maintain the set temperature. The temperature can be set between 50°C and 250°C. To turn the oven off, the knob must be turned to "0". There are 4 function settings for the main oven. Turn the control selector so that the symbol on the selector aligns with the marker on the control panel:

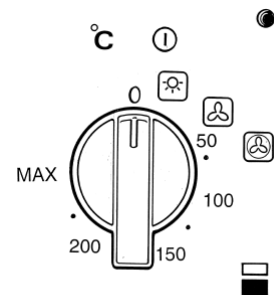

Figure 8 - main oven control knob



### Light ON

When the control knob is turned to this position, the interior light will switch on.



### Fan assisted cooking

Fan assisted cooking uses the fan and circular heating element to evenly distribute the heat throughout the oven. Select the required temperature on the control knob.



### Defrost setting

This function operates the fan without the oven heating up. This is suitable for defrosting frozen food.

0

### OFF position.

# Top oven controls

The thermostat determines the temperature inside the oven during cooking. Turn the control knob clockwise to align the cooking temperature with the marker on the control panel. The temperature indicator will light up when a temperature is set, and turn off when the temperature has been reached. During cooking the thermostat will maintain the set temperature.

The temperature can be set between 50°C and 250°C. To turn the oven off, the knob must be turned to "0". There are 3 function settings for the top oven.

Turn the control selector so that the symbol on the selector aligns with the marker on the control panel:

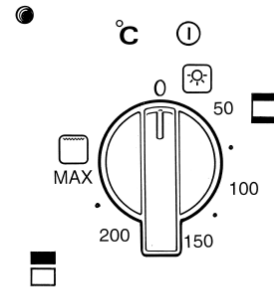

Figure 8 - top oven control knob



## Light ON

When the control knob is turned to this position, the interior light will switch on.



## Top heating element (grill)

Use this function for grilling or top oven heat which is suitable for browning food. Turn the control knob, as far as it will go, to the grill symbol.  
**OFF position.**



## Top and bottom heating element (oven)

Use this function for conventional oven cooking. Select the required temperature on the control knob. The top oven is not fan assisted.





# Electronic programmer





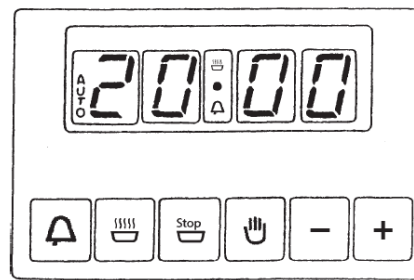

The electronic programmer incorporates the following functions:

- 24 hour clock with luminous display
- 10 hour timer
- automatic oven cooking
- semiautomatic oven cooking

The electronic programmer operate only on the “large” oven.





## Programming buttons and their functions.

-  beep
-  cooking time in automatic mode
-  cooking stop time
-  manual operation
-  decrease – all programs
-  increase – all programs





## Luminous symbols

When “**AUTO**” blinks, this means that the timer is in “automatic” mode but no setting has yet been made.

When “**AUTO**” remains permanently alight, this means that the timer is in “automatic” mode and already programmed

-  automatic cooking
-  timer in operation
-  plus “**AUTO**” blinking: programming error

If there is no symbol alight other than the digits of the clock, this means that the timer is in “manual” mode.

The timer incorporates a digital electronic clock with luminous numbers indicating the hours and minutes. When the appliance is first connected to the a.c. supply, or following a power cut, three zeroes will blink in the timer window. To set the clock, press  and  hold the two buttons and together,  and  use the or symbol to select the exact time. The longer the increase or decrease button is held, the faster the numbers will scroll. If convenient, the clock can be turned back to **00.00**:



to scroll back further at this point, release all the buttons and repeat the sequence, pressing and holding the decrease button until the time appears in the display.

## Normal cooking without using the timer

To operate the oven in manual mode — in other words without using the timer — the blinking “**AUTO**” indicator must be deactivated by pressing the  button.

### Automatic cooking (programmed start and stop times)

To cook food in the oven using the automatic timer, proceed as follows:

- establish how long the food needs to cook 
- enter the cooking stop time 
- select the temperature and the cooking method.

Once these steps have been completed, the “**AUTO**” indicator will light up permanently in the display, confirming that the oven has been programmed.

Practical example: we want to cook food for a period of 30 minutes, ending at 14.00.



- Pressing and holding , enter 0.30 in the display.
- Pressing and holding , enter 14.00 in the display.

This done, the display will revert to the current time and “**AUTO**” reappears, confirming that the settings have been acknowledged and memorized. At 13.30 (14.00 minus 30 minutes) the oven switches on automatically and the symbols and **AUTO** will appear for as long as cooking continues. The oven will then switch off automatically at 14.00, triggering a beep that can be silenced by pressing .



### Semiautomatic cooking

A. Programming the duration



B. Programming the stop time.

A) Select the duration for which the food is to cook by pressing . The oven will switch on immediately, with the symbols “**AUTO**” and  showing in the display.

Once the set duration has elapsed, cooking will stop and the beep sounds intermittently. Silence the beep as indicated above.

B) Set the time for cooking to stop, by pressing . The oven will switch on immediately, with the symbols “**AUTO**” and  showing in the display. When the set time comes around, cooking will stop and the beep sounds intermittently. Silence the beep as indicated above.

Current programming status can be displayed at any given moment by pressing the corresponding button.

It is also possible to cancel the current selection at any moment by pressing  and resetting the display to zero. Pressing  at this point, the programmer will revert to manual mode.

**CAUTION: if the oven is disconnected from the power supply, or in the event of a power failure, the clock resets to zero and all programming will be lost. When power is restored, three zeroes appear.**

# Using the grill

## KEEP THE DOOR OPEN WHILST GRILLING

Move the shelf to the first or second position from the top.

Select the symbol  on the top oven control selector, and preheat the grill for 5 minutes. Place the food in the middle of the grill pan and position the pan so the food is near but not touching the top element.

Do not line the grill pan with aluminium foil or wrap food items with foil before placing under the grill.

Aluminium foil has a high reflectivity which can damage grill elements.

When fitting the handle, hook the handle over the edge of the grill pan and through the wire rack at a central point along the grill pan edge, (Figure 9). Lower the handle fully down to fit.

## THE GRILL SHOULD ONLY BE USED FOR A MAXIMUM OF 30 MINUTES

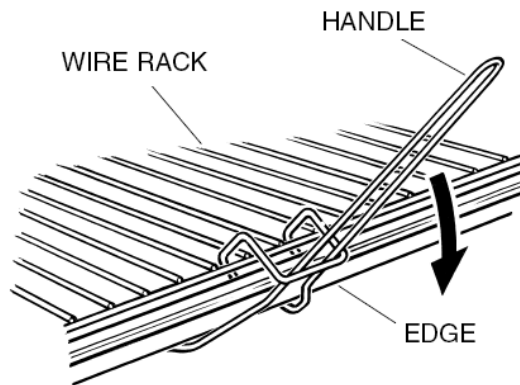

Figure 9 - fitting the handle

# Cleaning the oven

Before cleaning the oven, wait for it to cool down.

It is best to clean the bottom of the oven after every use and not allow the food or spots of oil to remain and become permanent stains.

Wash surfaces in warm soapy water. For stubborn marks on glass surfaces, a mild cream cleaner can be used. Dry parts with a soft cloth.

For the interior surfaces in the oven use normal oven cleaners but always read the manufacturer's instructions on how to use them.

**Do not** use caustic paste, abrasive wire, powders or hard instruments to clean any part of the appliance.

# Cleaning the glass doors

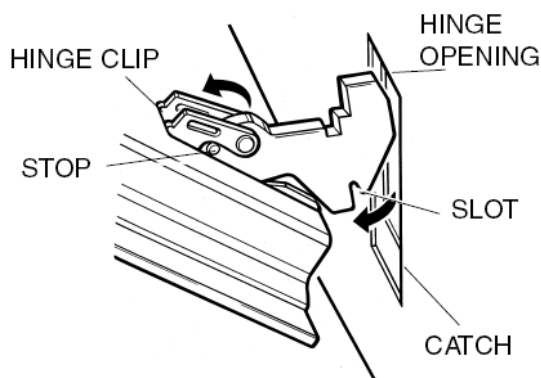

Figure 10 - removing the oven door

Ensure the oven doors are cool before cleaning. Removal of a door makes it easier to clean the door, the door surround and the seals.

To remove a door proceed as follows:

1. Open the door fully.
2. Raise one hinge clip and rotate it towards you as far as the stop (Figure 10). Repeat the procedure with the second hinge clip on the other side of the door.
3. Raise the door gently until it comes to rest against the hinge clips.
4. Grip the edges of the door and lift the door clear of the catches in the hinge openings.
5. When cleaning the door, take care not to move the clips from their position.
6. Once cleaning is complete, lift the door and slide the hinges into the hinge openings.
7. Engage the slots on the hinges with the catches in the hinge openings.
8. Check that the weight of the door is fully supported on the hinges.
9. Lower the door and raise the hinge clips, then return them away from you and back to their starting positions.
10. Check that the seal is in place then close the door. Make sure that the inner face of the door meets and shuts against the seal all around.

# Changing the lamps

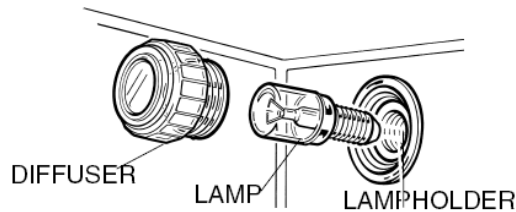

Figure 11 - changing the lamp

Wait for the oven to cool.

Unscrew and remove the diffuser. Unscrew the lamp from the lampholder. Replace lamp and diffuser (Figure 11).

The replacement lamp must be of the same type, voltage and wattage (25W SES 300°C).

## Mains lead replacement

**Do not attempt to repair or replace the mains connecting cable yourself, consult a qualified electrician.**

## For best cooking results

### Grill

#### Even cooking:

- Ensure that the grill pan is positioned centrally below the grill element.

#### Fat splattering:

To avoid fat splattering onto the oven interior

- Ensure that the grill pan is not lined with foil

### General Baking

#### Uneven rising of cakes:

- Oven shelf is not level.

#### Prevent sinking of cakes:

- Preheating of fan ovens – not always necessary
- Cooking at too high a temperature – reduce temperature by 25°C for fan cooking.
- When using soft margarine use an all in one method instead of the traditional creaming of the margarine and sugar. when using a food mixer or processor do not over cream soft margarine.

#### Over/undercooking:

- Reduce or increase cooking times or temperatures to suit personal taste.

# Troubleshooting guide

If you are experiencing problems with your oven, check the following problems and solutions below before contacting the Helpline.

Problem	Solution
Nothing works	Check that: The main oven wall switch is switched to ON. Other appliances are working to determine if there is a general power failure. The circuit breaker in the distribution box has not tripped.
Grill does not work.	Check that the top heating element <input type="checkbox"/> has been selected on the Function Selector control.
Grill keeps turning ON and OFF.	When the grill is operated at a setting less than 'High' it is controlled by the regulator – this is normal.



This appliance/fitting is marked according to the European directive 2002/96/EC on Waste Electrical and Electronic Equipment (WEEE). By ensuring this product is disposed of correctly, you will help prevent potential negative consequences for the environment and human health, which could otherwise be caused by inappropriate waste handling of this product.

The symbol on the product, or on the documents accompanying the product, the Crossed Out Wheelie Bin symbol, indicates that this appliance/fitting may not be treated as household waste. Instead it shall be handed over to the applicable collection point for the recycling of electrical and electronic equipment. Disposal must be carried out in accordance with local environmental regulations for waste disposal. For more detailed information about treatment, recovery and recycling of this product, please contact your local authority, your household waste disposal service or the retailer where you purchased the product.